

NEGRO

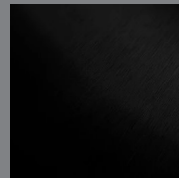

NOGAL



DORADO

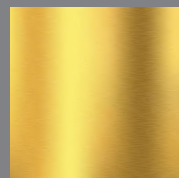

OXFORD



GRIS



BASE LORETTA

ESTRUCTURA DE HERRERÍA ENTABLILLADO TIPO LAMBRÍN

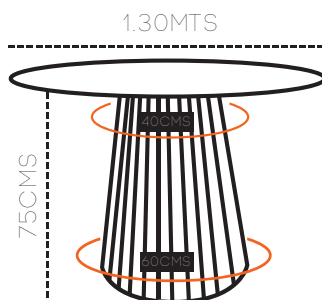

PARA CUBIERTAS DE 1.30MTS HASTA 1.50MTS

COSTO
\$8,500.00

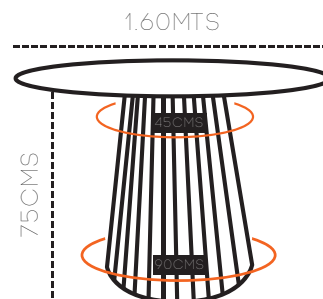

PARA CUBIERTAS DE 1.60MTS HASTA 1.80MTS

COSTO
\$10,500.00

BASE VICTORIA

ESTRUCTURA DE HERRERÍA CON LÁMINA

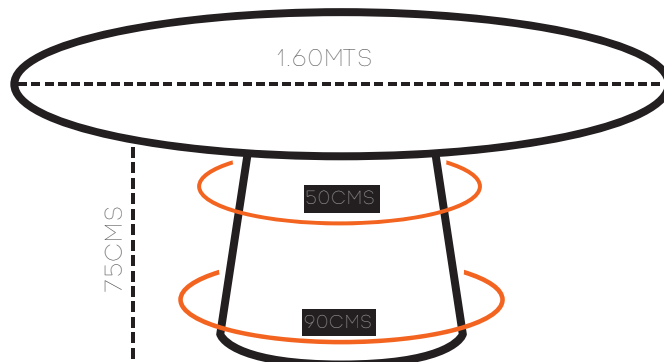

PARA CUBIERTAS DE 1.60MTS HASTA 1.80MTS

COSTO
\$10,500.00

BASIC NOVA

ESTRUCTURA DE HERRERÍA
ENTABLILLADO TUBULAR

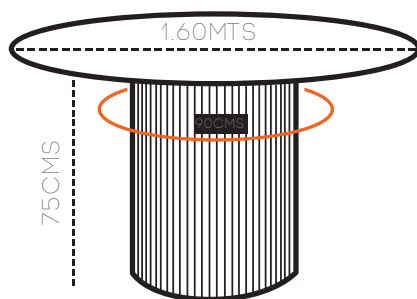

PARA CUBIERTAS DE 1.60MTS HASTA 1.80MTS
COSTO

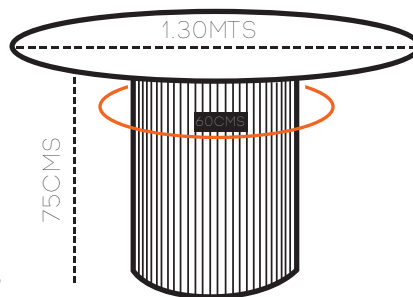

PARA CUBIERTAS DE 1.30MTS HASTA 1.50MTS
COSTO

NEGRO

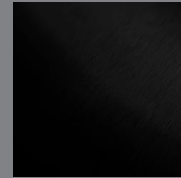

NOGAL

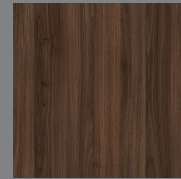

DORADO



OXFORD

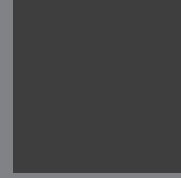

GRIS



BASE ZENITH

ESTRUCTURA DE HERRERÍA
CON LÁMINA

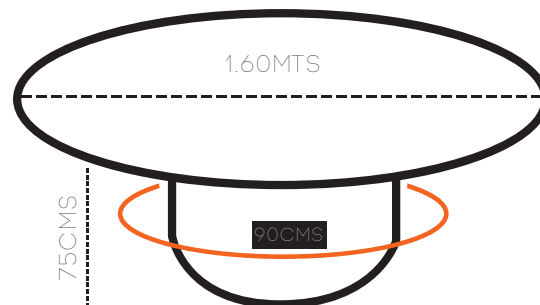

PARA CUBIERTAS DE 1.60MTS HASTA 1.80MTS

BASIC ZAFIRO

ESTRUCTURA DE HERRERÍA

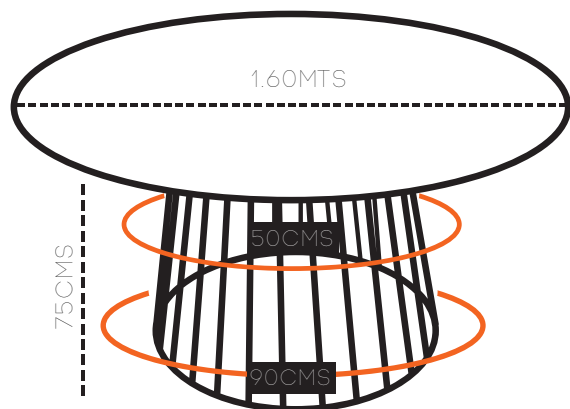

PARA CUBIERTAS DE 1.60MTS HASTA 1.80MTS



NEGRO

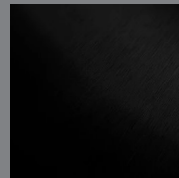

NOGAL



DORADO

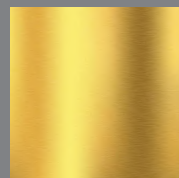

OXFORD



GRIS



BASIC DELUXE

ESTRUCTURA DE HERRERÍA

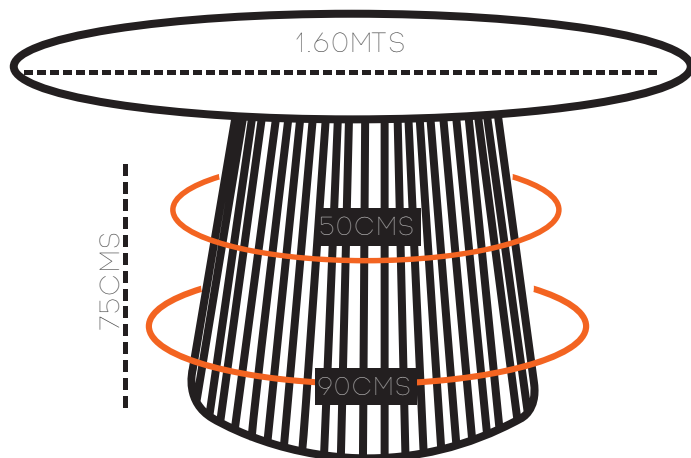

PARA CUBIERTAS DE 1.60MTS HASTA 1.80MTS

BASE VALENTINA

ESTRUCTURA DE HERRERÍA
ENTABLILLADO TUBULAR

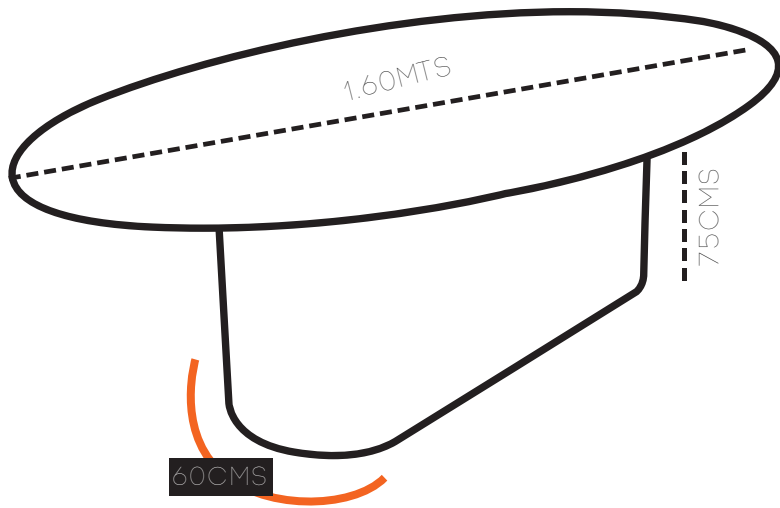

NEGRO



NOGAL



DORADO

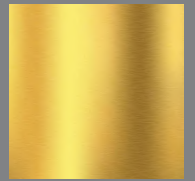

OXFORD



GRIS



BASIC CORTEX

ESTRUCTURA DE HERRERÍA
CON LAMINA

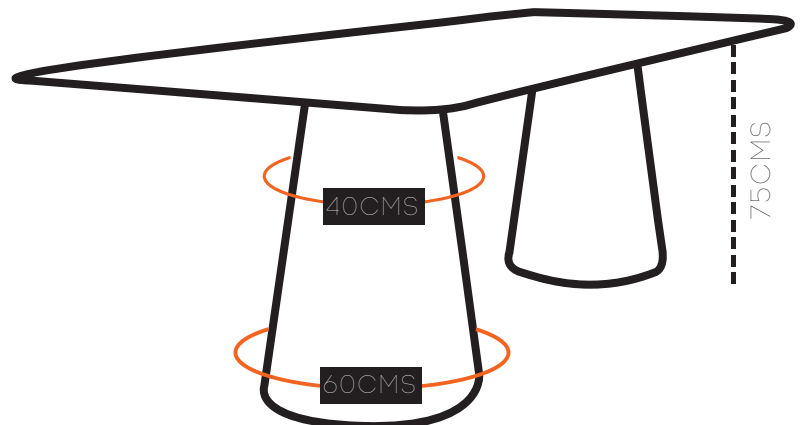

NEGRO

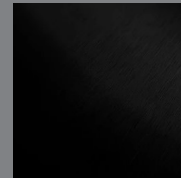

NOGAL



DORADO



OXFORD



GRIS



BASE TRIANA

ESTRUCTURA DE HERRERÍA
CON LÁMINA

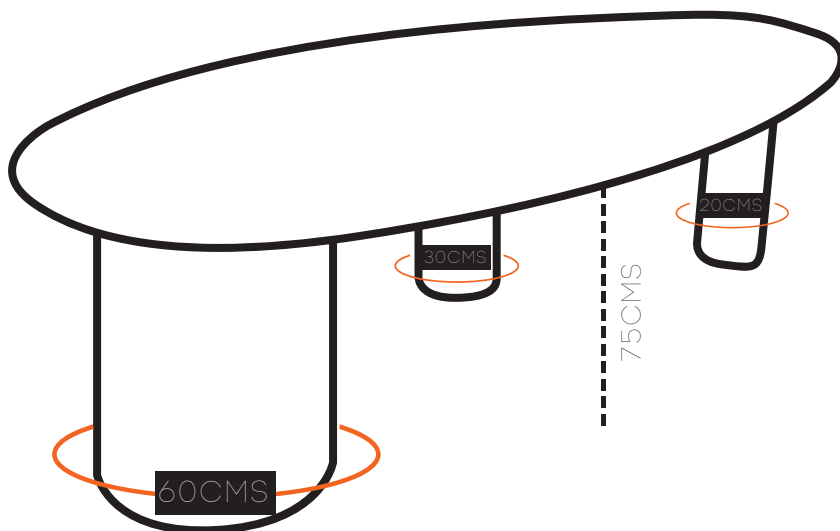

BASE PORTO

ESTRUCTURA DE HERRERÍA
CON LÁMINA

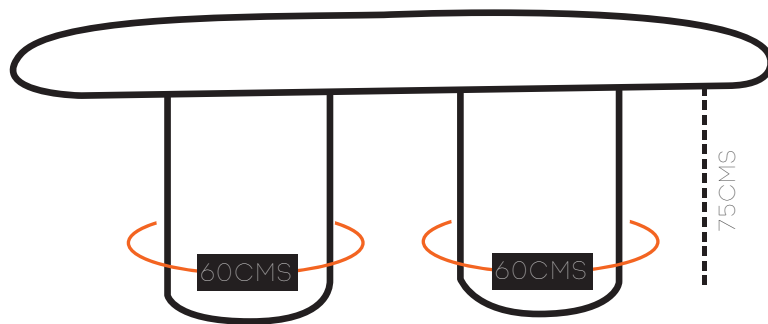

NEGRO



NOGAL

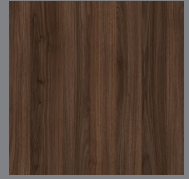

DORADO



OXFORD

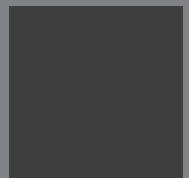

GRIS



BASE BOREAL

ESTRUCTURA DE HERRERÍA
ACABADO HORNEADO

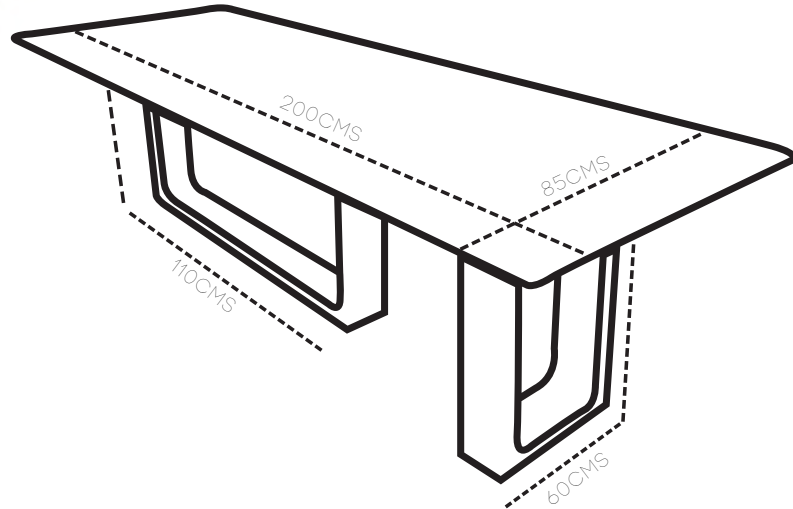

BASIC CAVALLI

ESTRUCTURA DE HERRERÍA

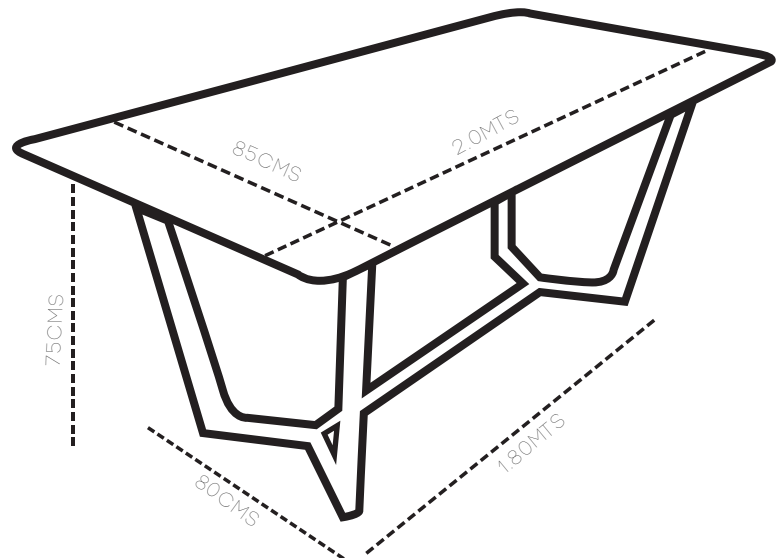

NEGRO



NOGAL

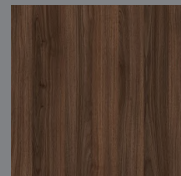

DORADO



OXFORD



GRIS



BASE LUNARIS

ESTRUCTURA DE HERRERÍA

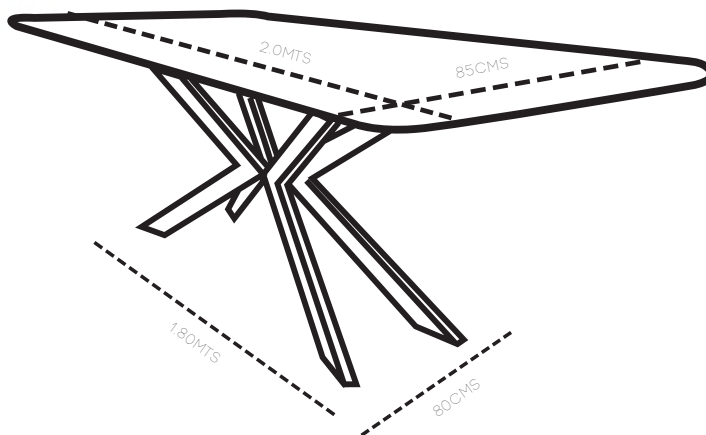

BASE LÚMINA

ESTRUCTURA DE HERRERÍA



75CMS

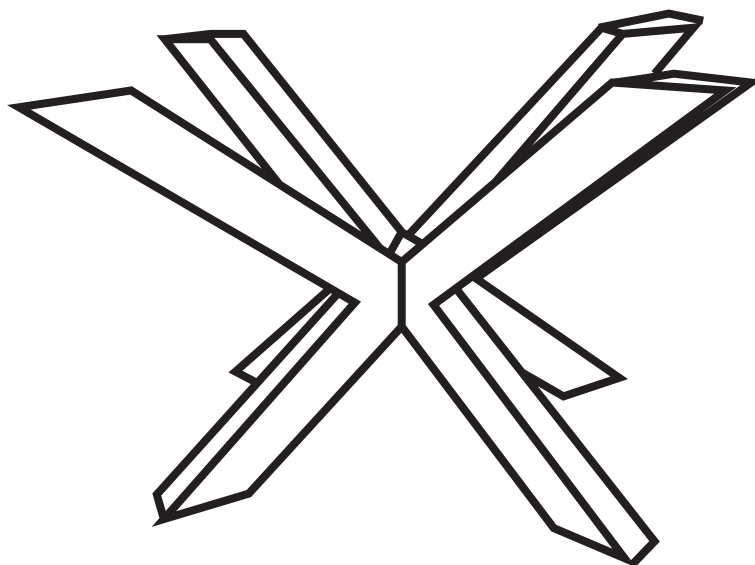

1.20MTS



PROPORCIONES DE BASE CIRCULAR

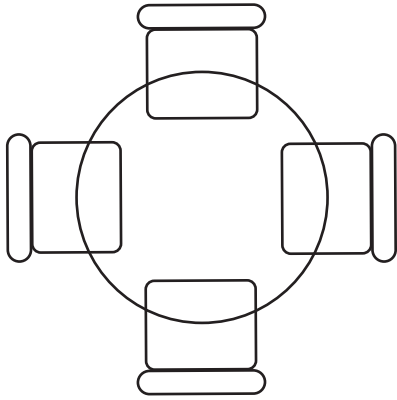

DIAMETRO
1.10MTS

ESPESOR
2CMS, CANTO PULIDO

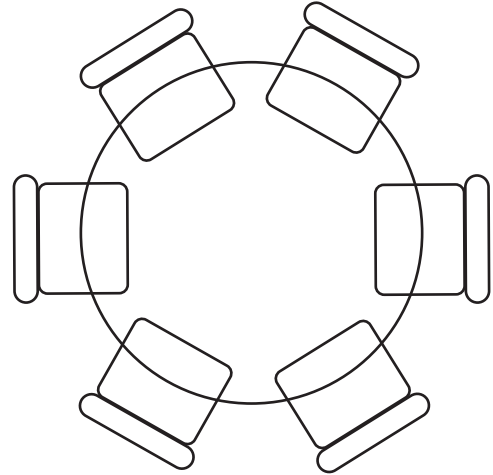

DIAMETRO
1.20MTS

ESPESOR
2CMS, CANTO PULIDO

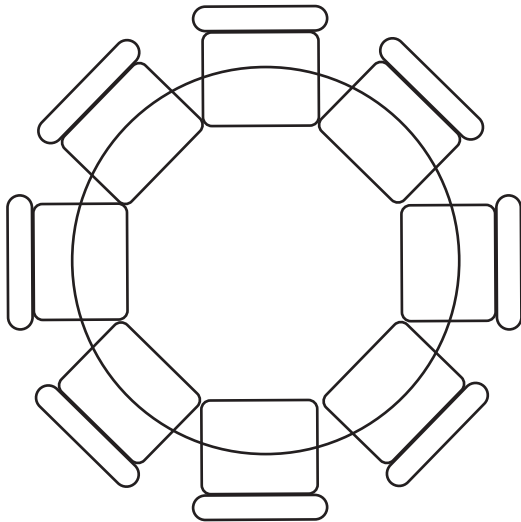

DIAMETRO
1.50MTS

ESPESOR
2CMS, CANTO PULIDO

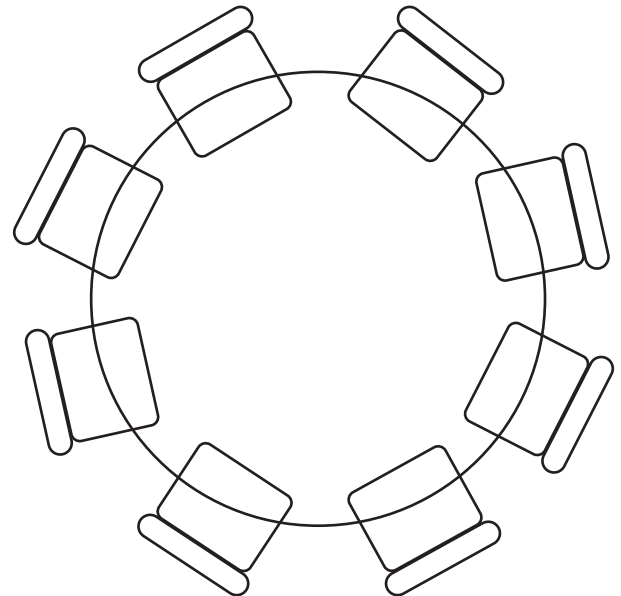

DIAMETRO
1.80MTS

ESPESOR
2CMS, CANTO PULIDO

PROPORCIONES DE BASE OVALADA

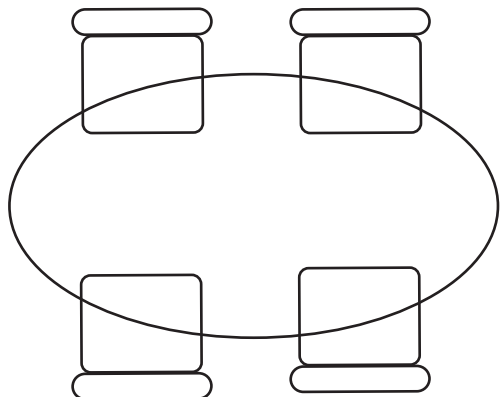

MEDIDAS
152CMS X 72CMS

ESPEJOR
2CMS, CANTO PULIDO

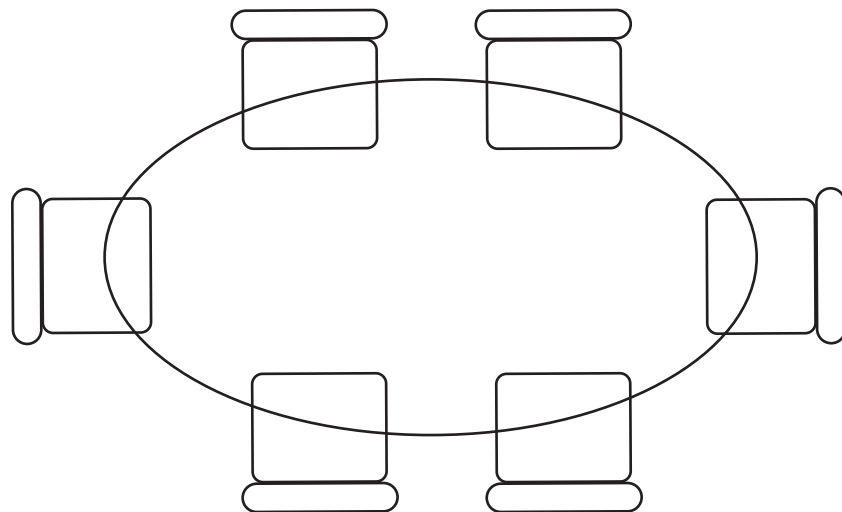

DIAMETRO
183CMS X 92CMS

ESPEJOR
2CMS, CANTO PULIDO

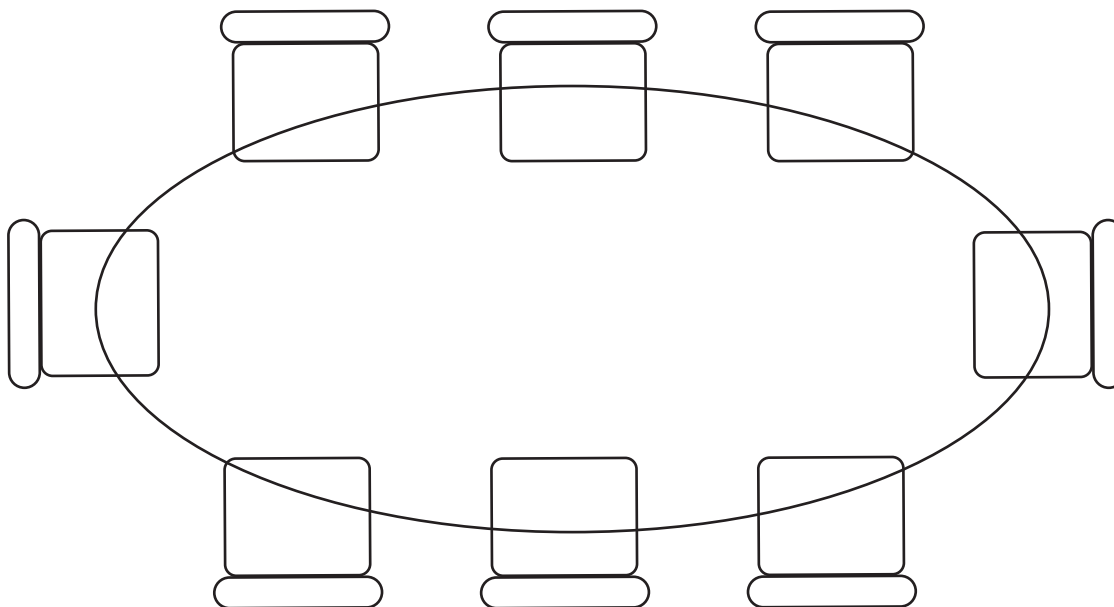

DIAMETRO
2.44MTS X 1.07MTS

ESPEJOR
2CMS, CANTO PULIDO

PROPORCIONES DE BASE CUADRADA

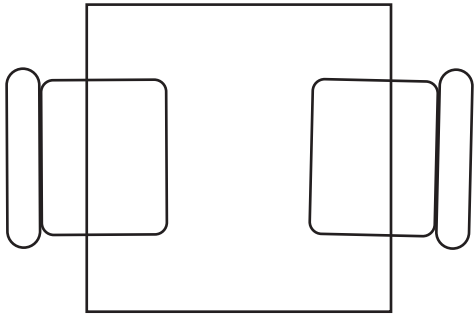

DIAMETRO
90CMS X 90CMS

ESPEJOR
2CMS, CANTO PULIDO

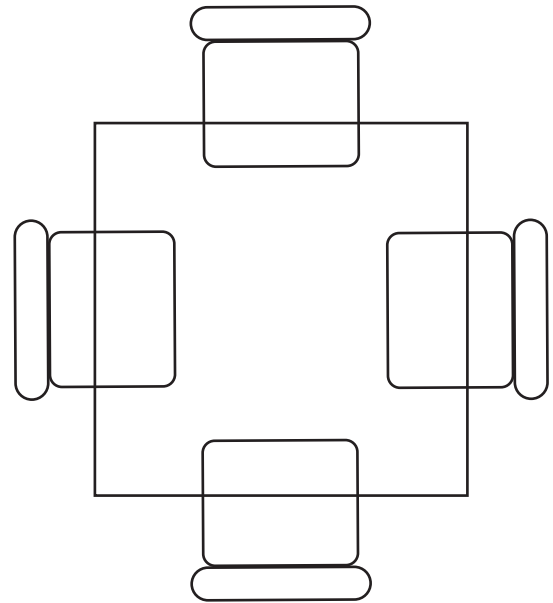

DIAMETRO
110CMS X 110CMS

ESPEJOR
2CMS, CANTO PULIDO

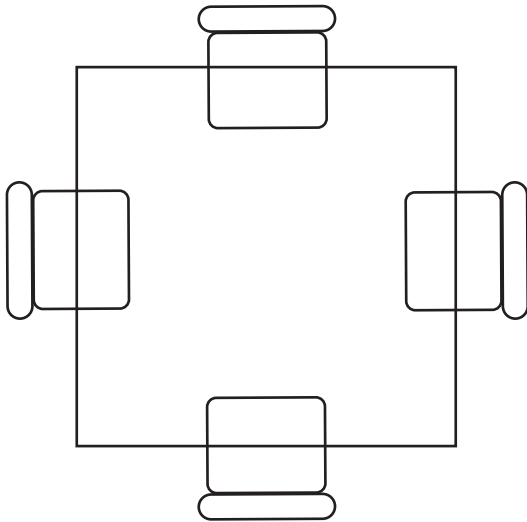

DIAMETRO
1.30MTS X 1.30MTS

ESPEJOR
2CMS, CANTO PULIDO

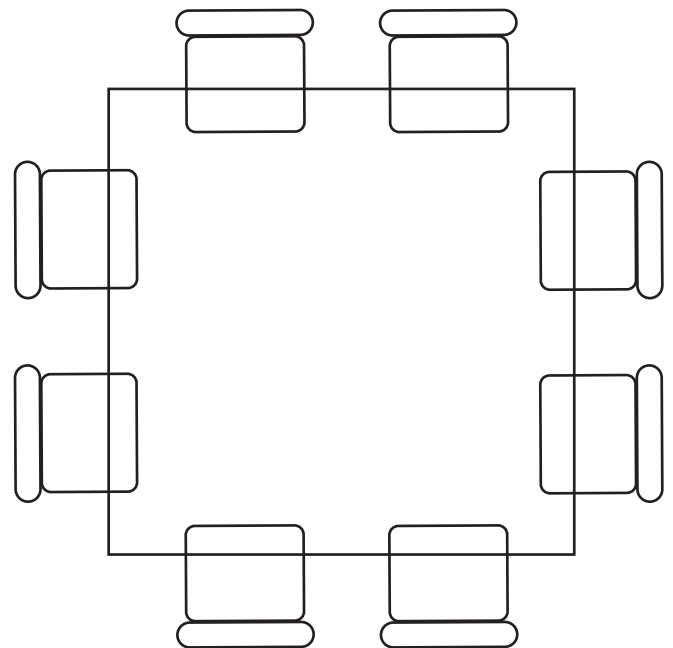

DIAMETRO
150CMS X 150CMS

ESPEJOR
2CMS, CANTO PULIDO

PROPORCIONES DE BASE RECTANGULARES

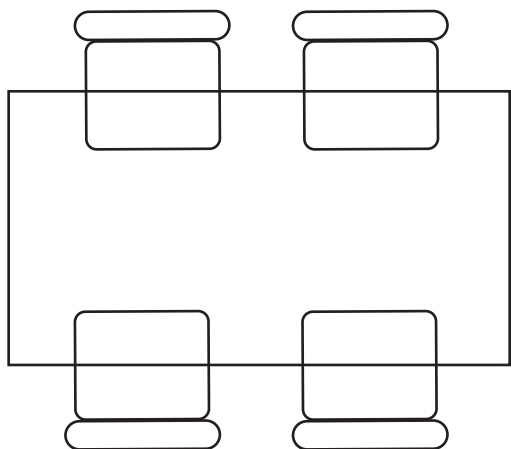

DIAMETRO
152CMS X 72CMS

ESPEJOR
2CMS, CANTO PULIDO

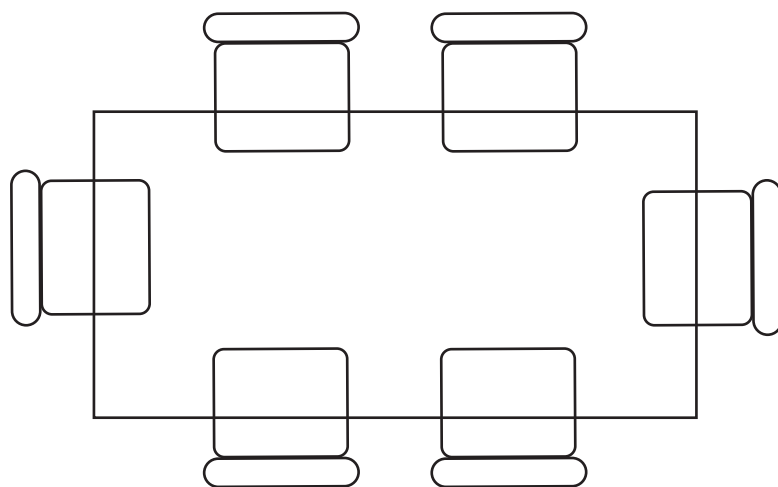

DIAMETRO
183CMS X 92CMS

ESPEJOR
2CMS, CANTO PULIDO

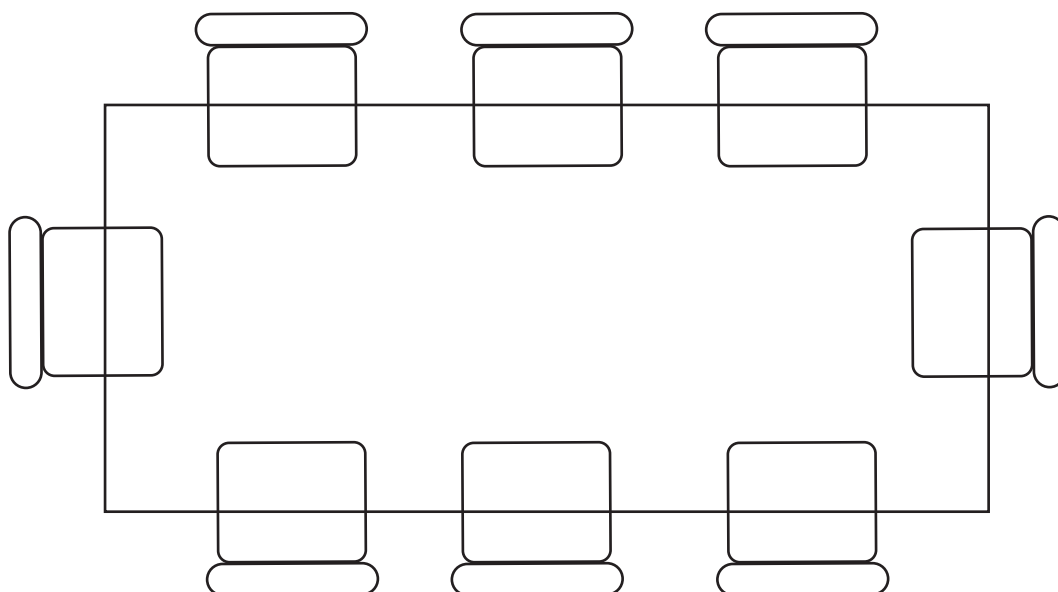

DIAMETRO
2.44MTS X 1.07MTS

ESPEJOR
2CMS, CANTO PULIDO

DIAMETRO
152CMS X 72CMS

ESPEJOR
2CMS, CANTO PULIDO

PROPORCIONES DE BASES MESAS DE CENTRO



PROPORCIONES DE BASES MESAS DE CENTRO

CLASSIC

110CMS X 80CMS
90CMS X 60CMS
80CMS X 55CMS
60CMS X 40CMS

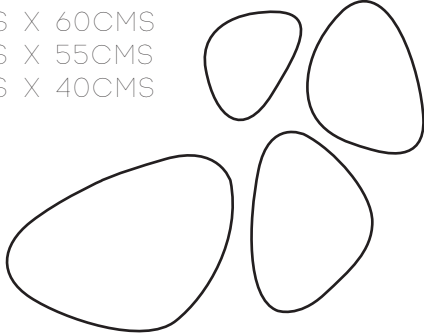

CLASSIC PLUS

110CMS X 70CMS
95CMS X 65CMS

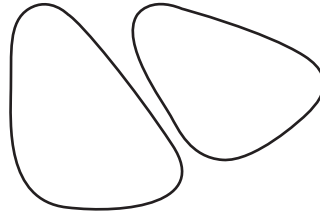

GOTA

120CMS X 65CMS
85CMS X 70CMS

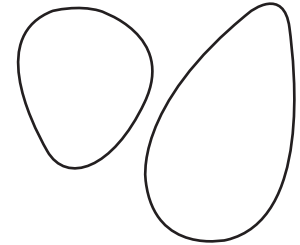

CIRCULARES

50CMS
60CMS
70CMS
80CMS
90CMS

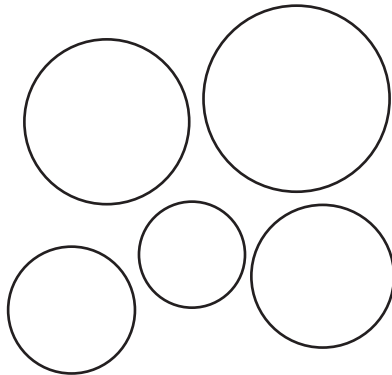

OVALO

170CM X 50CM
170CM X 50CM

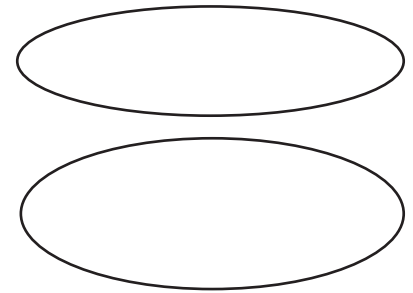

RECTÁNGULO

40 X 80CMS
50 X 90CMS
60 X 100CMS
60 X 120CMS
60 X 150CMS

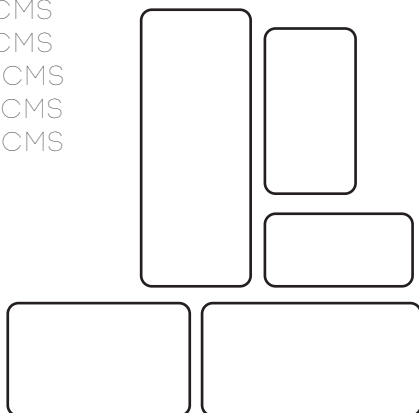

CUADRADO

50 X 50CMS
60 X 60CMS
70 X 70CMS
80 X 80CMS
90 X 90CMS

